

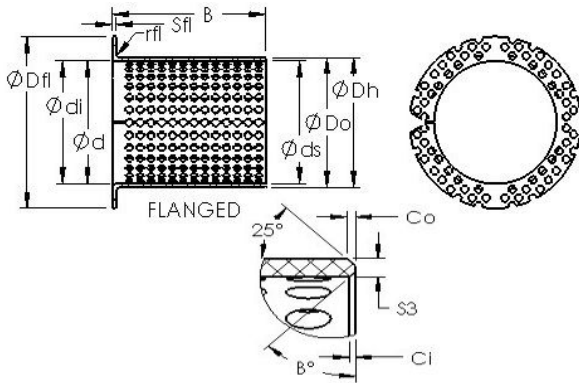

BEARING-SINGAPORE (PTE)LTD.



AST ASTT90 F14070 plain bearings

Bearing No. ASTT90 F14070

Bore Diameter	140 mm
Outer Diameter	145 mm
Bearing Type	flanged
Shaft Dia., Nominal (d)	140.0000
Shaft Size (ds) - 140 -0.190 / -0.242	140 0.190 / 0.242
Housing Bore Dia. (Dh) - 145 +0.040 / -0	145 +0.040 / 0
Bearing Outside Diameter, Nominal(Do)	145.000
Bearing Bore after Mounting (di) - 145 +0.100 / -0	145 +0.100 / 0
Wall Thickness (S3)	2.500
Bearing Length, Nominal (B)	70.000
Bearing Length Tolerance (B tol.) - +0 / -0.40	+0 / 0.40
OD Chamfer Length (Co)	1.800
ID Chamfer Angle (B deg.)	45
ID Chamfer Length (Ci)	0.600
Flange Dia. (Dfl pm 0.5)	165.000
Flange Thickness (Sfl)	2.500
Flange Radius (rfl)	2.000
Material	Wrapped bronze with lubrication holes.

ASTT90 F14070 Bearing 2D drawings and 3D CAD models